

KH 1 Hexode

This battery hexode can be utilized for three different purposes, viz:

1) As a frequency-changer with a separate oscillator valve, such as the KC 4 which is specially designed for the purpose. The R.F. signal is applied to the first grid and the oscillator signal to the third grid. The screens, grids two and four, are given a positive potential of 60 V. The pitch of the first grid is such that A.G.C. can be employed, with excellent cross-modulation characteristics; the conversion conductance, for a battery valve, is very high, being 450 $\mu\text{A/V}$.

2) As an R.F. vari-mu pentode in R.F. and I.F. amplifiers. The second and third grids are again given a potential of 60 V, whilst the fourth grid serves as suppressor and is accordingly earthed, this arrangement giving high mutual conductance (1.4 mA/V) with a low battery current (2.95 mA).

3) As a variable-mu R.F. tetrode in R.F. or I.F. amplifiers. The second and fourth grids are joined and supplied with 60 V and the third grid is earthed. In this case the mutual conductance is slightly higher than when the valve is used as a pentode (1.5 mA/V), and the anode current somewhat lower (2.8 mA); the control, however, is less rapid and the internal resistance is lower.

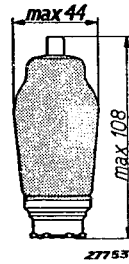

Fig. 1
Dimensions in mm.

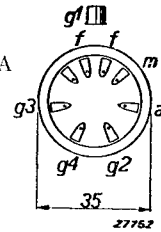
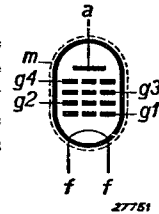

Fig. 2
Arrangement of electrodes and base connections.

FILAMENT RATINGS

Heating: direct by battery; parallel supply.

Filament voltage. $V_f = 2.0 \text{ V}$

Filament current. $I_f = 0.135 \text{ A}$

CAPACITANCES

$C_{g1} = 7.8 \mu\text{F}$

$C_{g1g3} = 0.17 \mu\text{F}$

$C_{g3} = 12.5 \mu\text{F}$

$C_{ag1} = < 0.002 \mu\text{F}$

$C_a = 16.3 \mu\text{F}$

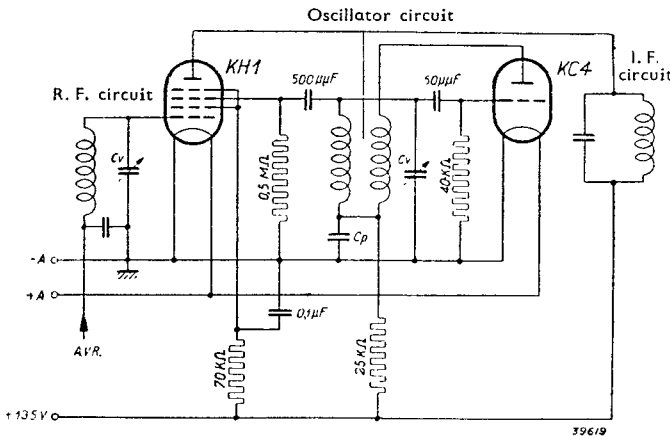

Fig. 3
Circuit diagram showing the KH 1 used as a frequency-changer.

KH 1

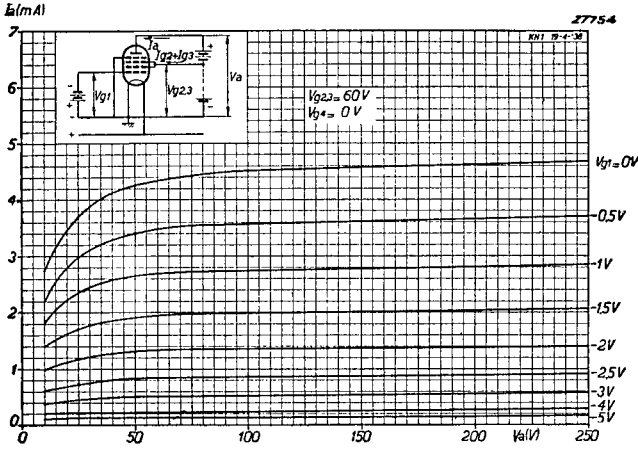

Fig. 4
 I_a/V_a characteristics of the KH 1 used as a pentode.

OPERATING DATA: KH 1 employed as a frequency-changer

Anode voltage	$V_a = 135 \text{ V}$		
Voltage on grid 2.	$V_{g2} = 60 \text{ V}$		
Voltage on grid 4.	$V_{g4} = 60 \text{ V}$		
Grid leak, grid 3	$R_{g3} = 0.5 \text{ M ohm}$		
Oscillator voltage, grid 3	$V_{osc} = 10 \text{ V}_{eff}$		
Grid bias.	$V_{g1} = -1.5 \text{ V}^1)$	$-8 \text{ V}^2)$	$-9.5 \text{ V}^3)$
Anode current	$I_a = 1 \text{ mA}$	—	—
Screen-grid current	$I_{g2} \div I_{g4} = 1.1 \text{ mA}$	—	—
Conversion conductance	$S_c = 450 \mu\text{A/V}$	$4.5 \mu\text{A/V}$	$1 \mu\text{A/V}$
Internal resistance	$R_i = 1 \text{ M ohm}$	$> 10 \text{ M ohms}$	$> 10 \text{ M ohms}$

¹⁾ Without control. ²⁾ Conductance controlled to 1 : 100. ³⁾ Limit of control.

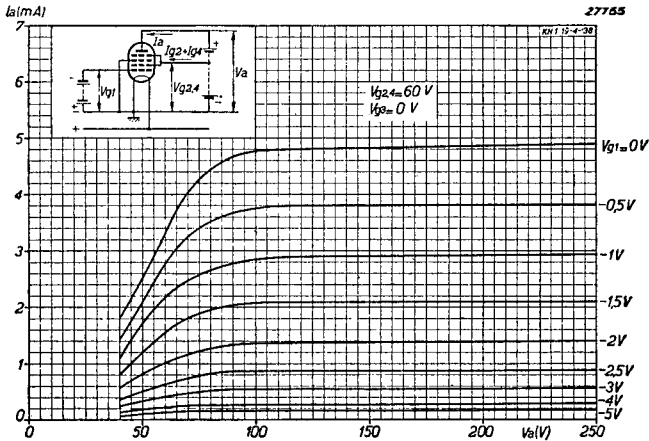

Fig. 5
 I_a/V_a characteristics of the KH 1 used as tetrode.

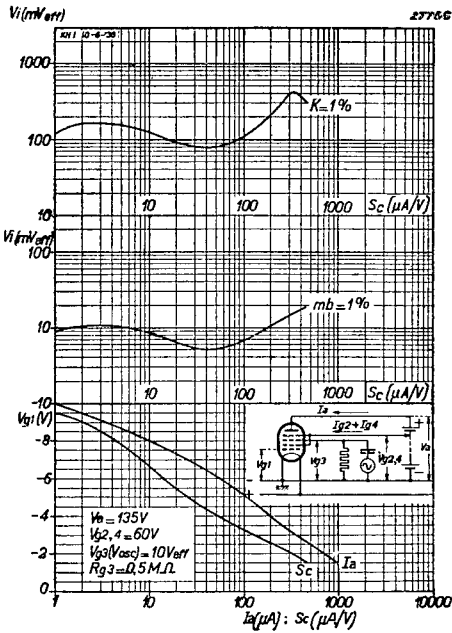

Fig. 6

KH 1 as a frequency-changer.

Upper diagram. Effective value of the alternating grid voltage as a function of the conversion conductance, with 1% cross-modulation.

Centre diagram. Effective value of the alternating grid voltage as a function of the conversion conductance, with 1% modulation hum.

Lower diagram. Conversion conductance S_c and anode current I_a as functions of the grid bias.

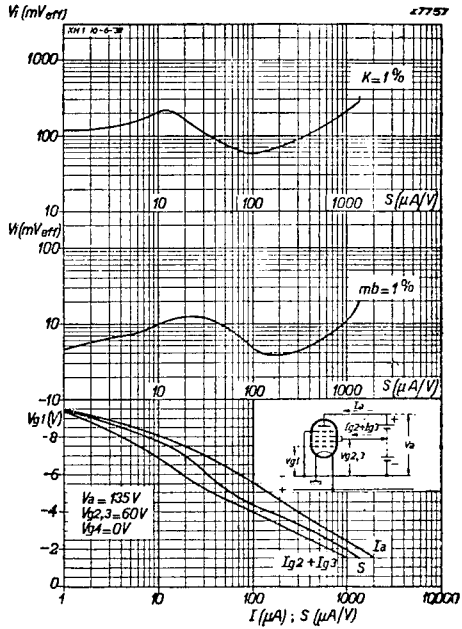

Fig. 7

KH 1 as a pentode.

Upper diagram. Effective value of the alternating grid voltage as a function of the mutual conductance, with 1% cross-modulation.

Centre diagram. Effective value of the alternating grid voltage as a function of the mutual conductance, with 1% modulation hum.

Lower diagram. Mutual conductance S , screen-grid current $I_{g2} + I_{g3}$, and anode current I_a as functions of the grid bias.

OPERATING DATA: KH 1 connected as a pentode (R.F. or I.F. amplifier)

Anode voltage	$V_a = 135 V$		
Voltage on grid 2.	$V_{g2} = 60 V$		
Voltage on grid 3.	$V_{g3} = 60 V$		
Voltage on grid 4.	$V_{g4} = 0 V$		
Grid bias.	$V_{g1} = -1.5 V^1)$	$-7.5 V^2)$	$-9.3 V^3)$
Anode current	$I_a = 2 \text{ mA}$	—	—
Screen-grid current	$I_{g2} + I_{g3} = 0.95 \text{ mA}$	—	—
Mutual conductance.	$S = 1,400 \mu A/V$	$14 \mu A/V$	$1 \mu A/V$
Internal resistance	$R_i = 1.3 \text{ M ohms}$	$> 10 \text{ M ohms}$	$> 10 \text{ M ohms}$

OPERATING DATA: KH 1 connected as a tetrode (R.F. or I.F. amplifier)

Anode voltage	$V_a = 135 V$		
Voltage on grid 2.	$V_{g2} = 60 V$		
Voltage on grid 3.	$V_{g3} = 0 V$		
Voltage on grid 4.	$V_{g4} = 60 V$		
Grid bias.	$V_{g1} = -1.5 V^1)$	$-8.5 V^2)$	$-11 V^3)$
Anode current	$I_a = 2.1 \text{ mA}$	—	—
Screen-grid current	$I_{g2} + I_{g4} = 0.7 \text{ mA}$	—	—
Mutual conductance.	$S = 1,500 \mu A/V$	$15 \mu A/V$	$1 \mu A/V$
Internal resistance	$R_i = 0.7 \text{ M ohm}$	$> 10 \text{ M ohms}$	$> 10 \text{ M ohms}$

¹⁾ Without control. ²⁾ Conductance controlled to 1 : 100. ³⁾ Limit of control.

MAXIMUM RATINGS

Anode voltage	V_{a}	= max. 150 V
Anode dissipation	W_a	= max. 0.4 W
Voltage, grid 2	V_{g2}	= max. 60 V
Dissipation, grid 2	W_{g2}	= max. 0.1 W
Voltage, grid 3	V_{g3}	= max. 60 V
Dissipation, grid 3	W_{g3}	= max. 0.1 W
Voltage, grid 4	V_{g4}	= max. 60 V
Dissipation, grid 4	W_{g4}	= max. 0.1 W
Grid voltage at grid current start	$(I_{g1} = + 0.3 \mu A)$	$V_{g1} = \text{max. } -0.2 \text{ V}$
	$(I_{g3} = + 0.3 \mu A)$	$V_{g3} = \text{max. } -0.2 \text{ V}$
Cathode current	I_k	= max. 10 mA
External resistance between grid 1 and cathode.	R_{g1k}	= max. 1 M ohm
External resistance between grid 3 and cathode	R_{g3k}	= max. 1 M ohm

TOLERANCES ON SCREEN-GRID CURRENT

- a) valve used as a frequency-changer ($V_a = 135 \text{ V}$, $V_{g2} = V_{g4} = 60 \text{ V}$, $V_{g3} = 10 \text{ V}_{\text{eff}}$, $V_{g1} = -1.5 \text{ V}$).
 $I_{g2} + I_{g4} = \text{max. } 1.45 \text{ mA}$
 $I_{g2} + I_{g4} = \text{min. } 0.75 \text{ mA}$
- b) valve used as a pentode ($V_a = 135 \text{ V}$, $V_{g2} = V_{g3} = 60 \text{ V}$, $V_{g4} = 0$, $V_{g1} = -1.5 \text{ V}$).
 $I_{g2} + I_{g3} = \text{max. } 1.3 \text{ mA}$
 $I_{g2} + I_{g3} = \text{min. } 0.7 \text{ mA}$
- c) valve used as a tetrode ($V_a = 135 \text{ V}$, $V_{g2} = V_{g4} = 60 \text{ V}$, $V_{g3} = 0 \text{ V}$, $V_{g1} = -1.5 \text{ V}$).
 $I_{g2} + I_{g4} = \text{max. } 0.9 \text{ mA}$
 $I_{g2} + I_{g4} = \text{min. } 0.5 \text{ mA}$

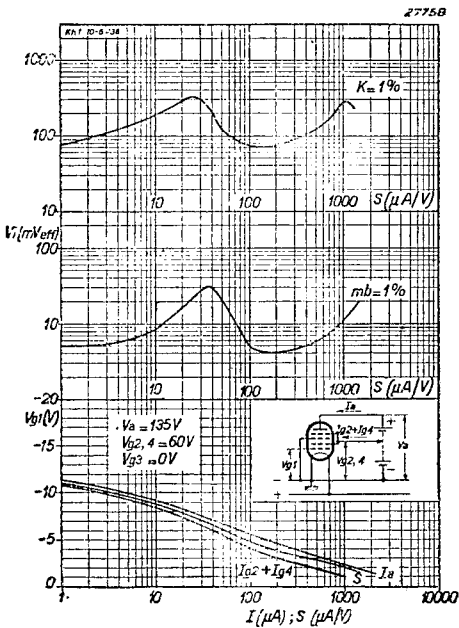

Fig. 8
 KH 1 used as a tetrode:
 Upper diagram. Effective value of the alternating grid voltage as a function of the mutual conductance, with 1 % cross-modulation.
 Centre diagram. Effective value of the alternating grid voltage as a function of the mutual conductance, with 1 % modulation hum.
 Lower diagram. Mutual conductance S , screen-grid current $I_{g2} + I_{g4}$, and anode current I_a as functions of the grid bias.